

**GE current**  
a Daintree company

LED HORTICULTURE LIGHTING SYSTEMS



# Arize Element<sup>®</sup> L1000

Enabling efficient growth at an industrial scale

## Sustainable

Efficacy levels surpassing 3.6  $\mu\text{mol}/\text{J}$  make the Element one of the most efficient grow lights in its class, lowering operating expenses

## Precise

Our XW Optic efficiently spreads light, reducing the number of fixtures by an average of 10 to 15% without sacrificing uniformity or crop quality

## Complete

Four application-specific models and eight spectrums ranging from dual-band purple to broad white ensure there is an Element for every farm

## Assembled in the USA

Tried and true manufacturing, a standard five-year warranty and a >50,000 hour lifetime ensure consistent, predictable yields for years to come

[www.led.com](http://www.led.com) for the latest in lighting innovations from the inventors of the LED



# Arize Element<sup>®</sup> L1000

## Why Element?

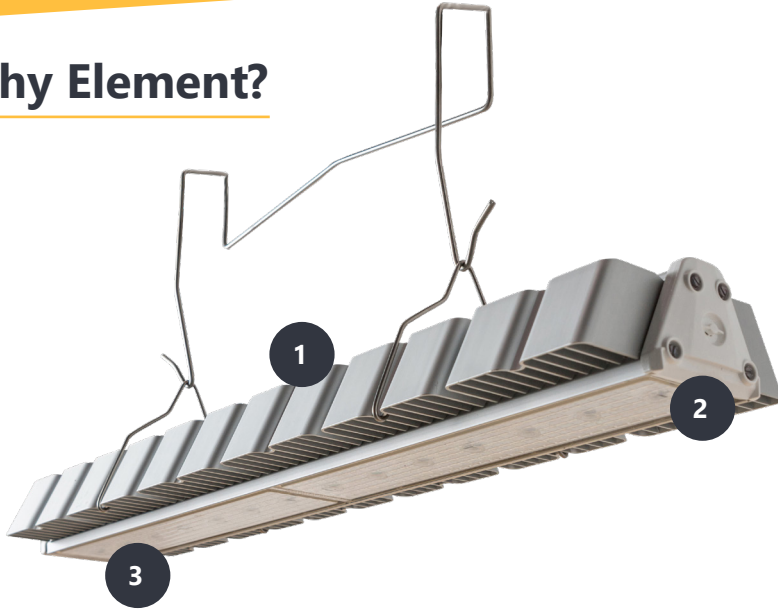

### 1 Purpose-Built

A heat sink that doesn't accumulate debris and LEDs protected by a lens are just two of the ways we designed reliability into the L1000. We've also designed all-new mounting brackets, further simplifying installation

### 2 Maximum Capability

We've simplified our language: broad white, broad pink and dual-band purple, all with high- and low-blue variants maximize year-round production for both sole-source and supplemental applications

### 3 Less Input. More Output

LED is more accessible than ever: Our XW optic reduces the number of fixtures required (more on that below), while efficacy levels surpassing 3.6  $\mu\text{mol}/\text{J}$  enable direct replacement of 1000W HPS fixtures, reducing energy costs by over 40%. Did we mention no relamping?

## XW Optic

Compared to the previous generation's Lambertian distribution, our new XW Optic precisely controls light dispersion, resulting in wider coverage in low headspace applications. It further reduces the number of fixtures by 10 to 15%, without sacrificing uniformity or crop quality, lowering capital investment.

### Lambertian Distribution

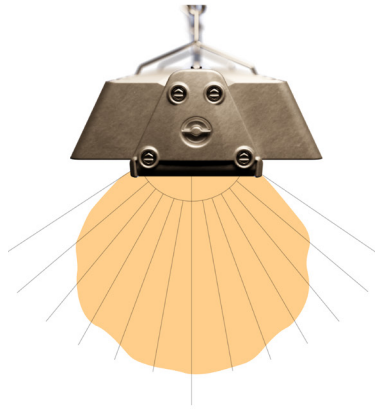

### XW Optic

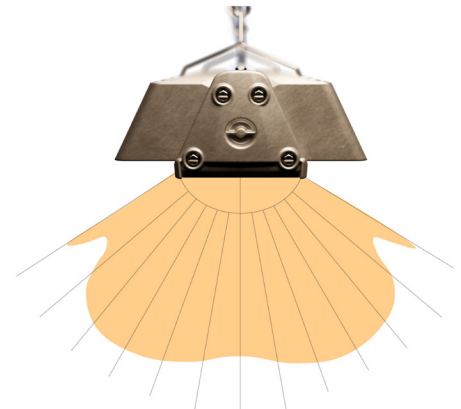

## Spectral Distribution

### Typical Spectral Distribution

Spectrum	Blue PF	Green PF	Red PF	Far Red PF
PPR	10.0%	0.0%	90.0%	0.0%
PPB	20.0%	0.0%	80.0%	0.0%
PKR	8.0%	15.0%	77.0%	0.0%
PKB	16.0%	15.0%	69.0%	0.0%
PKF	8.0%	15.0%	72.0%	5.0%
PKT	6.0%	6.0%	88.0%	0.0%
BRI	15.0%	38.0%	47.0%	0.0%
BRV	25.0%	38.0%	37.0%	0.0%



## Spectrum Table

Family	Spectrum	Typical photon flux <sup>1</sup> (μmol/s)	Power <sup>1</sup> (W)	Efficacy <sup>1</sup> (μmol/J)
L1000 (H order code)	PPR - Purple LB	1900	584	3.3
	PPB - Purple MB	1900	622	3.1
	PKT - Pink ELB	1900	610	3.1
	PKR - Pink LB	1900	627	3.0
	PKB - Pink MB	1900	642	3.0
	PKF - Pink FR	1900	644	3.0
	BRI - White MB	1750	658	2.7
	BRV - White HB	1750	683	2.6
L1000 High Efficacy (V order code)	PPR - Purple LB	1900	534	3.6
	PPB - Purple MB	1900	566	3.4
	PKT - Pink ELB	1900	542	3.5
	PKR - Pink LB	1850	572	3.2
	PKB - Pink MB	1850	593	3.1
	PKF - Pink FR	1800	571	3.2
L1000 High Output (C order code)	PKT - Pink ELB	2200	690	3.2
	PKR - Pink LB	2050	690	3.0
L1000 Extra High Output (F order code)	PPR - Purple LB	2600	850	3.1
	PKT - Pink ELB	2600	880	3.0
	PKR - Pink LB	2500	847	3.0
	PKB - Pink MB	2400	910	2.6

<sup>1</sup> Tested at maximum input voltage. Typical performance +/-10%

## Accessories

Order Code	SKU	Description	Order Code	SKU	Description
GECA60C16-OL04B	93153185	AC Leader Cable, 4'/1219mm, UL	GECA30H20-OO03B	93149020	Dimming Cable, 3 ft / 914 mm, UL/CE
GECA60D16-OL04B	93149021	AC Leader Cable, 4'/1219mm, CE	GEMB-WAS1	93153268	1.625 in / 40 mm Unistrut Mount
GECA60C16-5L04B	93153186	AC Leader Cable, 4', NEMA 5-15, UL	GEMB-WAA1	93154046	1.625 in / 40 mm Unistrut Offset Mount
GECA60C16-7L04B	93153187	AC Leader Cable, 4', 16AWG, NEMA L7-15, UL	GEMB-WAS2	93153269	2.75 in / 70 mm Square Mount
GECA60C16-8L04B	93153188	AC Leader Cable, 4', 16AWG, NEMA L8-20, UL	GEMB-CBH1	93153270	18 in / 457 mm Universal Cable Mount
GECA60FNA-NL00B	93153189	AC Field Installable Wieland Connector, UL/CE	GEMB-CBH5	93154044	24 in / 609 mm Universal Cable Mount
GECA30G14-EN03B	93149513	DC Interconnection Cable, 3'/914mm, UL/CE	GEMB-CBH4	93154043	36 in / 914 mm Universal Cable Mount
GECA30G14-EN06B	93149514	DC Interconnection Cable, 6'/1828mm, UL/CE	GEMB-CBH2	93153281	60 in / 1524 mm Universal Cable Mount
GEPS240-680D-BDGGGL	93149018	Power Supply, 120-277V UL/220-240V CE	GEMB-PAU1	93154745	90° Perpendicular Mounting Kit
GEPS240-680D-BGJGL	93149019	Power Supply, 277-480V UL/380-415V CE			



# Mechanical Outline

## Dimensions and Weight

	Length	Width	Height	Weight
L1000 Fixture	29.31" 745 mm	7.00" 178 mm	2.93" 75 mm	9.0 lbs 4.1 kg
Power Supply	13.12" 333 mm	1.81" 46 mm	5.94" 151 mm	7.0 lbs 3.2 kg

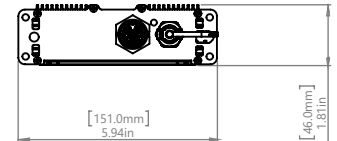
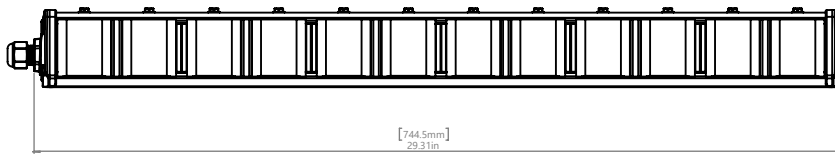
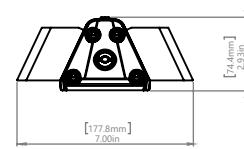

# Specifications

Dimming Range	0-10V	Max. Remote Mount Distance	18 ft (5.49 m)
Max Source Current	450uA	Cooling	Passive
Dim-to-Off <sup>3</sup>	Yes	Light Distribution	XW Optic
Dim Off Voltage	0.35-0.65 V (typ. 0.5 V)	IP Rating	IP66
Dim On Voltage	0.55-0.85 V (typ. 0.7 V)	Light Maintenance	L90: >50,000 hours <sup>6</sup>
Dimming Output Range	10%-100%	Warranty	Five-year system warranty
Power Factor	>0.99 <sup>4</sup>	System Certifications	cULus E492907, CE, UKCA

THD <10%<sup>5</sup>

Use with sink dimmers only  
<sup>3</sup> Refer to installation guide for dimming functionality details

<sup>4</sup> Tested at minimum input voltage  
<sup>5</sup> Tested at full intensity  
<sup>6</sup> Tested at 40°C per TM-21

# Order code table

Model	Family	Spectrum	Input Voltage	Optic	Options	Gen	Power Cable	Mounting Options
	<b>H</b>		<b>N</b> = No Power Supply	<b>B</b> = XW Optic	<b>N</b> = None	<b>2</b>	<b>N</b> = None	<b>N</b> = None
	<b>V</b>		<b>4</b> = 120-277V (UL) / 220-240V (CE)				<b>1</b> = 4'/122cm Leader Cable, No Plug, UL	<b>1</b> = 1.625"/40mm Unistrut
	<b>C</b>	See Spectrum Code Table	<b>5</b> = 277-480V (UL) / 380-415V (CE)				<b>3</b> = 4'/122cm Leader Cable, No Plug, CE	<b>2</b> = 1.625"/40mm Unistrut Offset
<b>GEHE</b>	<b>F</b>						<b>5</b> = Leader Cable, NEMA 5-15P Plug	<b>3</b> = 2.75"/70mm Square
							<b>7</b> = Leader Cable, NEMA L7-15P Plug	<b>H</b> = 18"/45mm Universal Cable
							<b>8</b> = Leader Cable, NEMA L8-20P Plug	



© 2021 Current Lighting Solutions, LLC. All rights reserved. GE and the GE monogram are trademarks of the General Electric Company and are used under license. Information provided is preliminary and subject to change without notice. All values are design or typical values when measured under laboratory conditions.

Not all product variations listed on this page are DLC qualified. Visit [qpl.designlights.org/horticulture](http://qpl.designlights.org/horticulture) to confirm qualification.

# Arize Element® L1000 Spectrum Guide

## Type R

High red light to optimize plant growth and photosynthesis

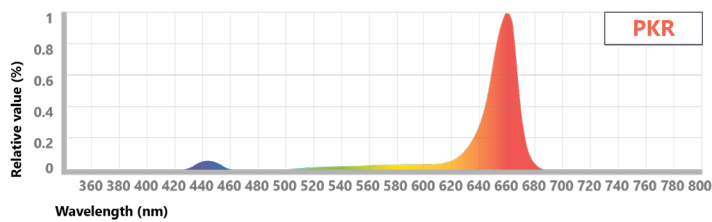
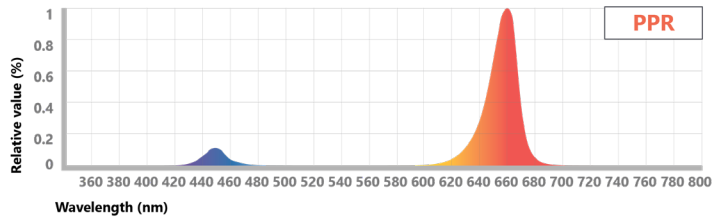

## Type B

Light that supports biomass and secondary metabolite production

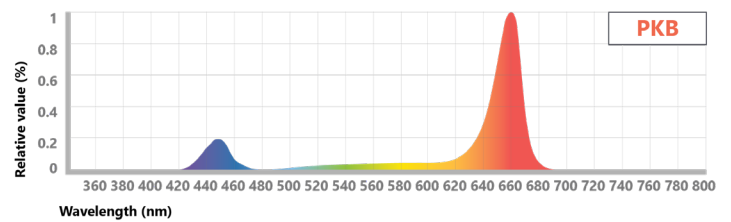
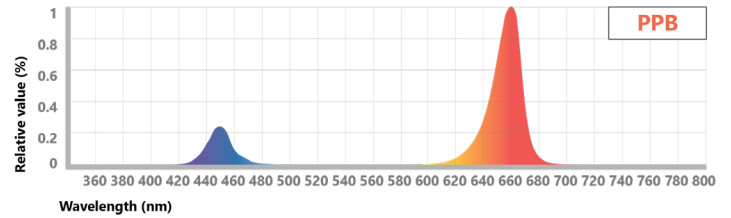

## Type F

Encourages a stretching and expansion response for more robust growth

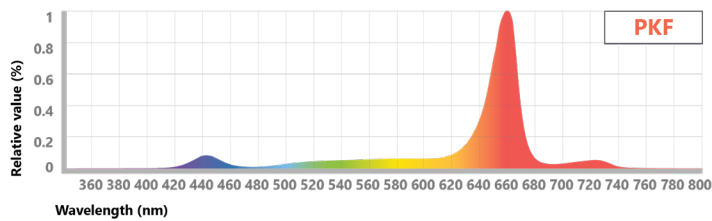
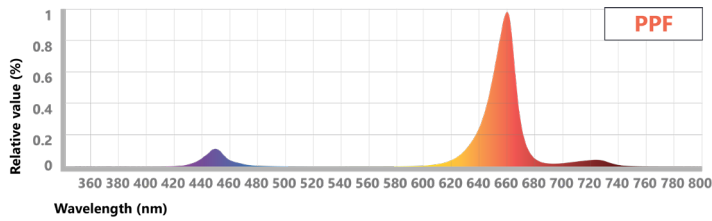

## Type BR

Increased blue ratio boosts secondary metabolite production to promote crop quality and phytochemical profile

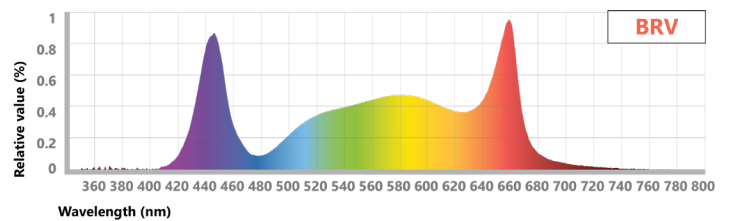
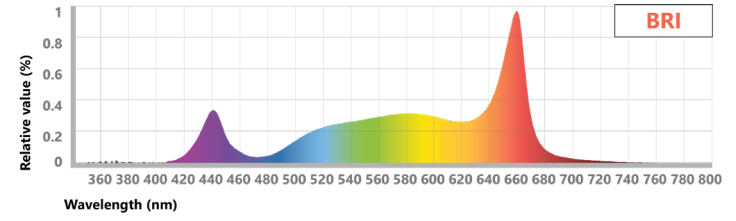

## Type T

Increased blue and green ratios boost secondary metabolite production to promote crop quality and phytochemical profile

